

# HB 2420 ET-EF 28 (240X200)

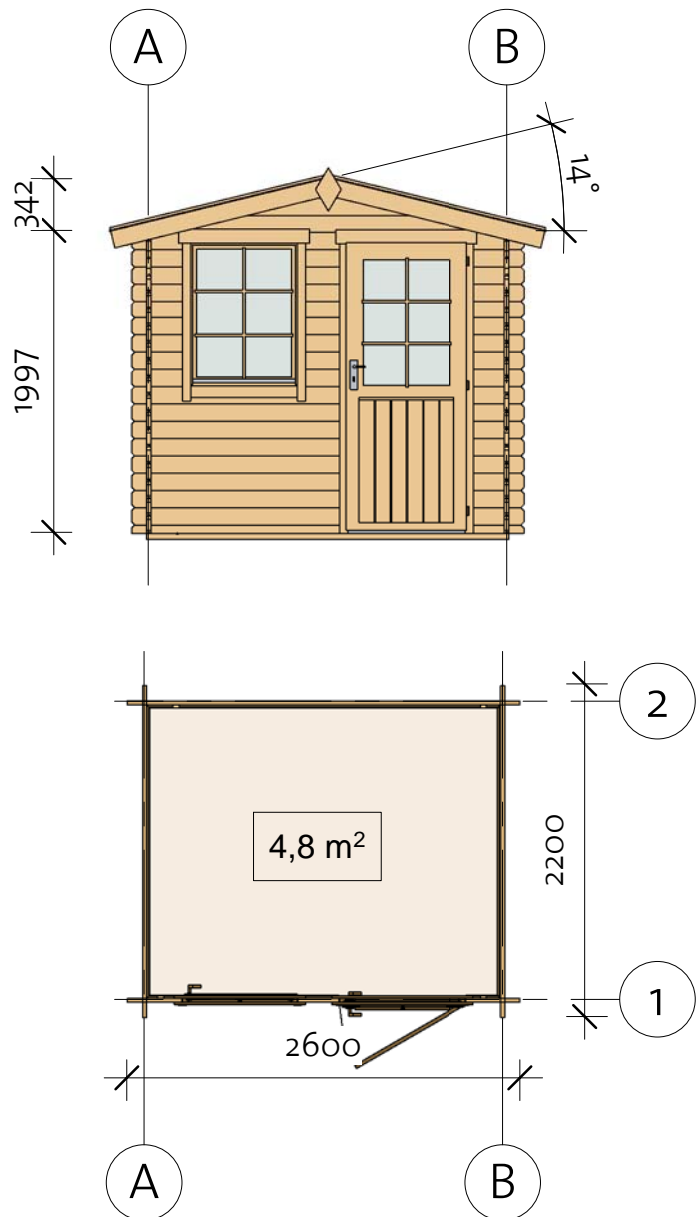

# HB 2420 ET-EF 28 (240X200)

Foundation

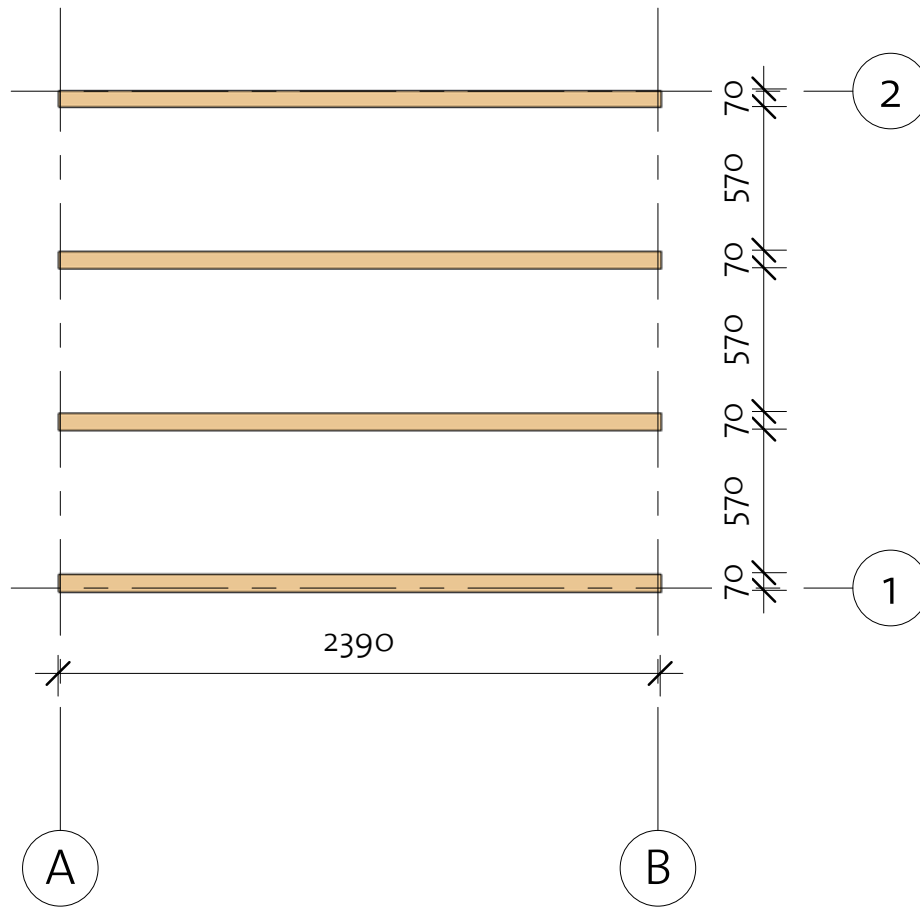

Impregnated foundation beams				
Mark	Type	Profile	Count	Length



IFB	IFB 70X40		4	2390
-----	--------------	---	---	------

# HB 2420 ET-EF 28 (240X200)

Floor Plan

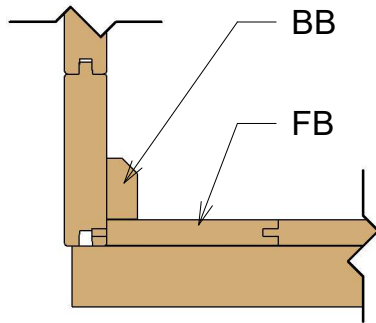
① Baseboard



Floor Schedule				
Mark	Type	Profile	Count	Length
FB	FB 17x114		22	1941
BB	BB 20x40		4	2400

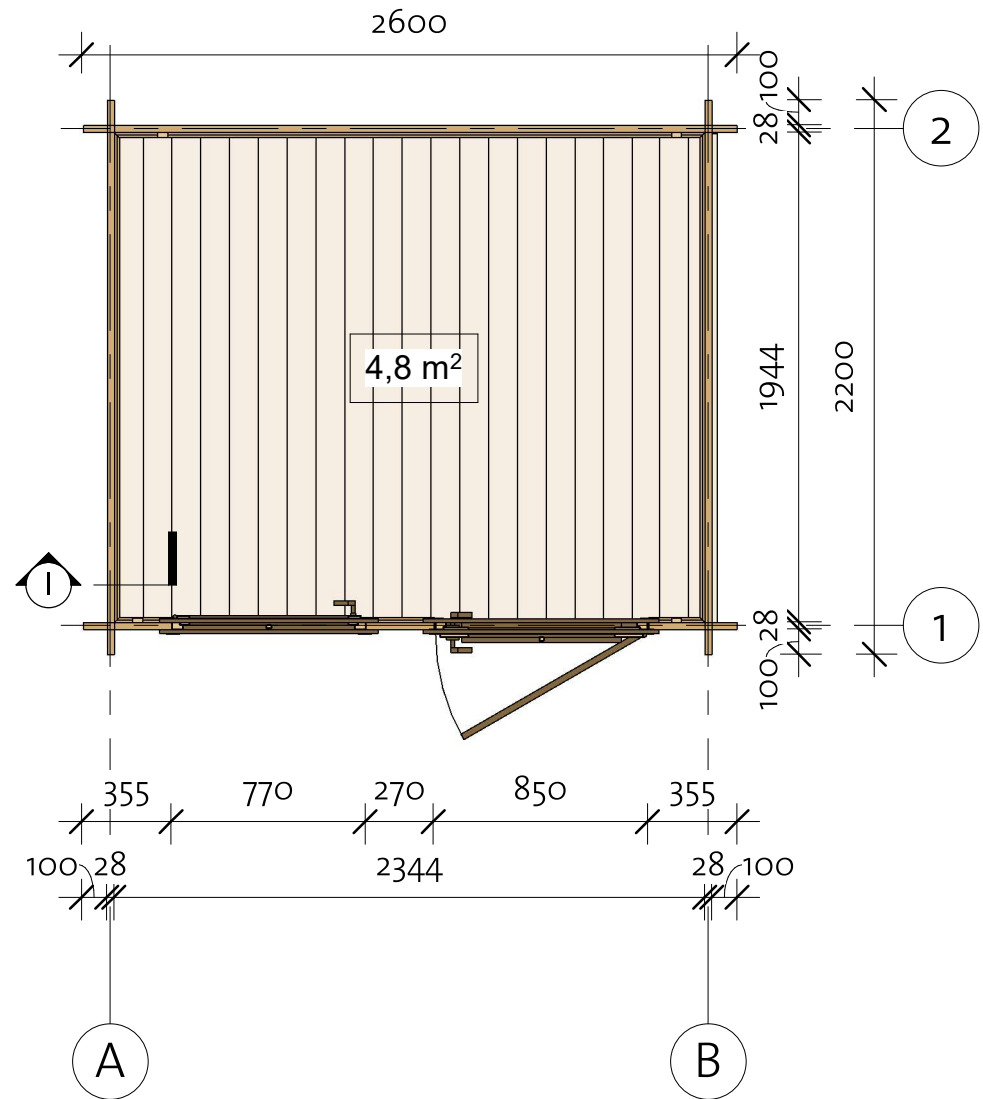

# HB 2420 ET-EF 28 (240X200)

Wall 1

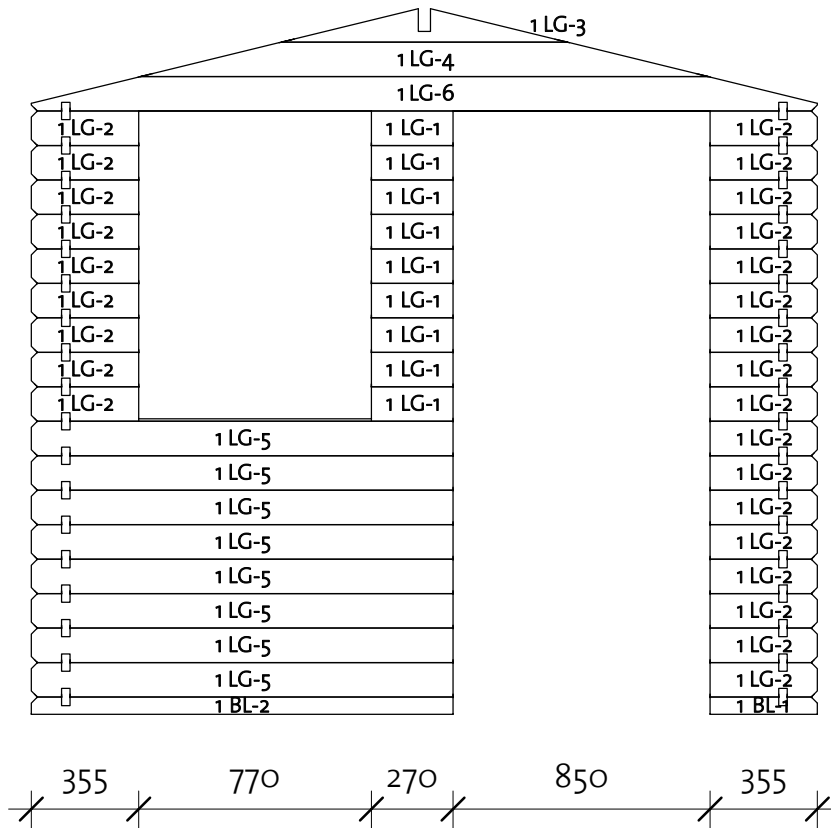



Wall 1			
Mark	Profile	Count	Cut Length

1BL-1	28x57	1	355
1BL-2	28x57	1	1395
1LG-1	28x114	9	270
1LG-2	28x114	26	355
1LG-3 *	28x114	1	944
1LG-4 *	28x114	1	1877
1LG-5	28x114	8	1395
1LG-6 *	28x114	1	2600

\* Gable - delivered premounted

Log Profile Wall 1	
Profile	Profile

28x57	
28x114	



# HB 2420 ET-EF 28 (240X200)

Wall A



Wall A			
Mark	Profile	Count	Cut Length

ALG-1	28x114	15	2200
ALG-2	28x114	1	2300
ALG-3	28x114	1	2400
ATL-1	28x114	1	2600

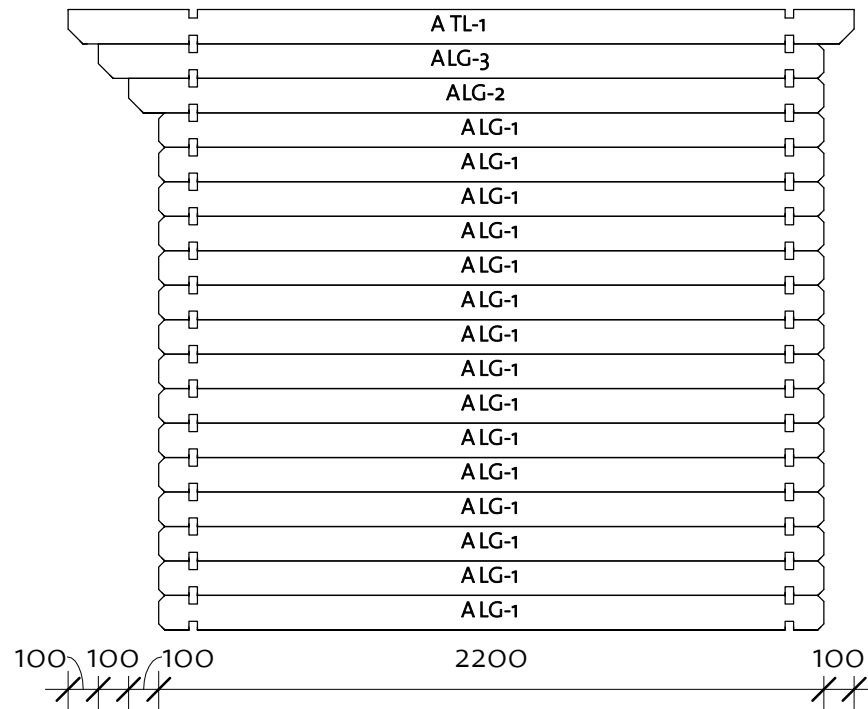

Log Profile Wall A	
Profile	Profile

28x114	
28x114	

# HB 2420 ET-EF 28 (240X200)

Wall B

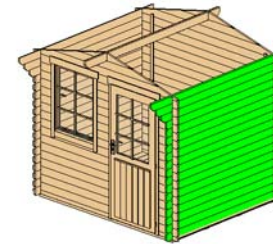

Wall B			
Mark	Profile	Count	Cut Length

BLG-1	28x114	15	2200
BLG-2	28x114	1	2300
BLG-3	28x114	1	2400
BTL-1	28x114	1	2600

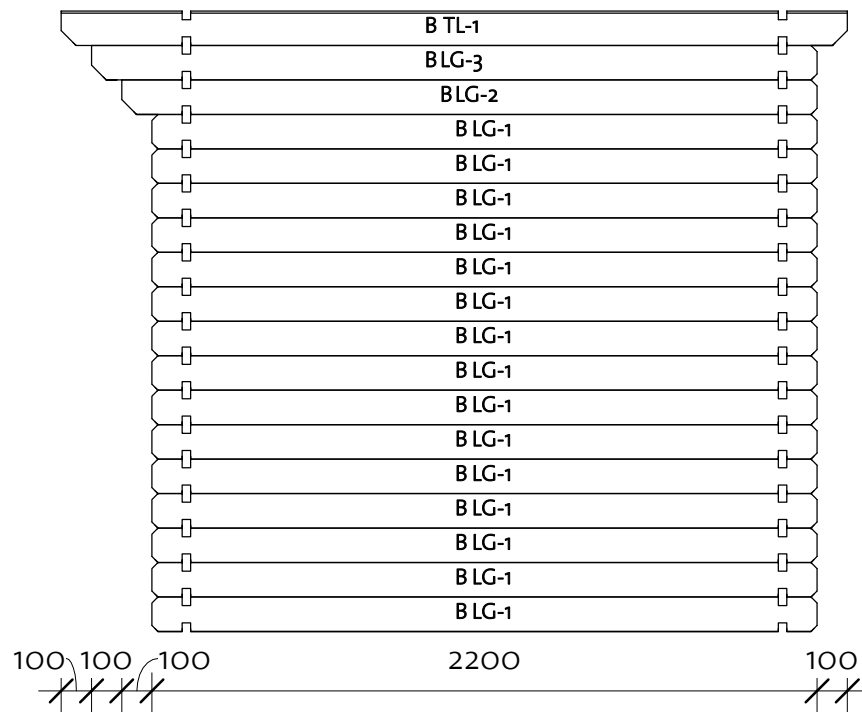



Log Profile Wall B	
Profile	Profile

28x114	
28x114	

# HB 2420 ET-EF 28 (240X200)

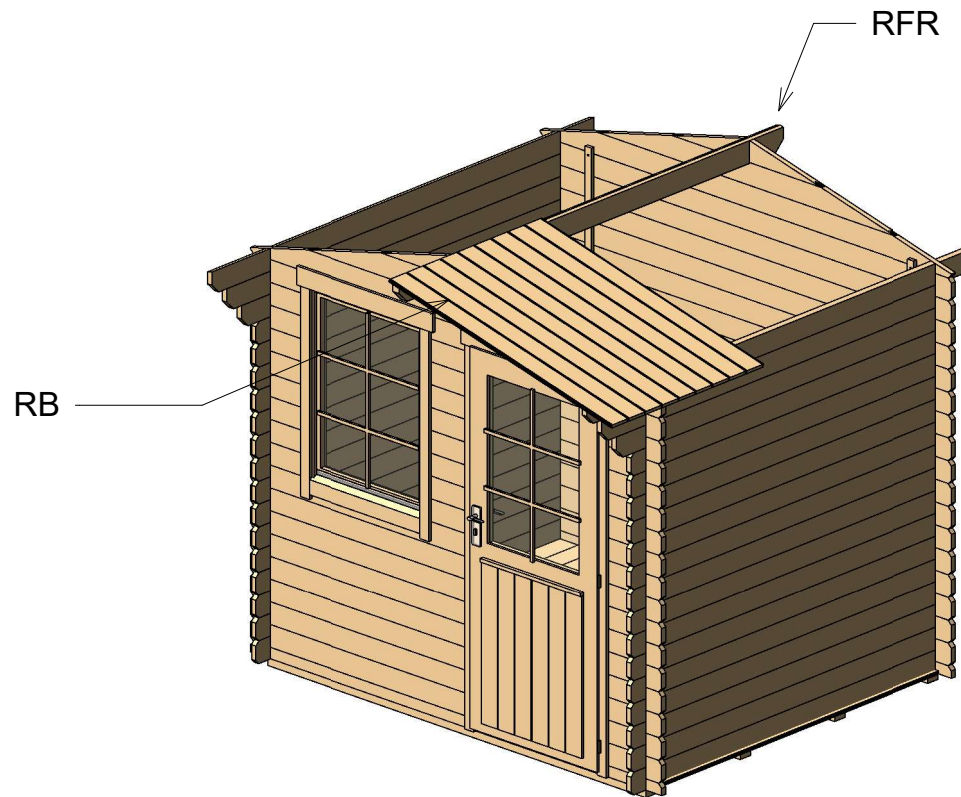
Roof 1



Roof				
Mark	Type	Profile	Count	Length
RFR	Ridge 40X120		1	2600
RB	17X114		48	1440



# HB 2420 ET-EF 28 (240X200)

Roof 2

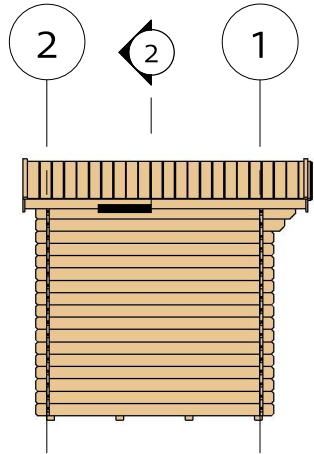

② Facia

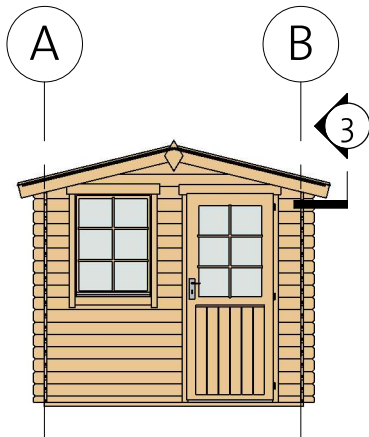
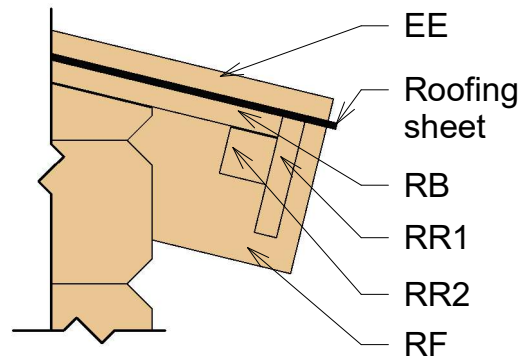



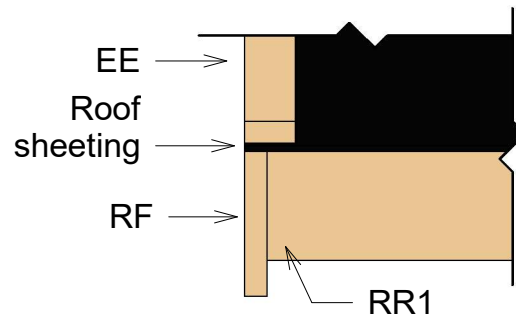











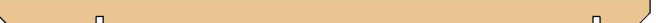













③ Roof Reinforcement



Fascia Schedule				
Mark	Type	Profile	Count	Length
EE	Eave Edging 18x40		4	1480
RF	Roof Fascia 18x120		4	1480
RR1	Roof reinforcement 18x95		2	2600
RR2	Roof reinforcement 38x38		2	2600



# HB 2420 ET-EF 28 (240X200)

## List of all items 1





2	BL-1	Log 28x57		1	2600
2	LG-3	Log 28x114		1	2600
2	LG-4	Log 28x114		17	2600
1	LG-6	Log 28x114		1	2600
	RFR	Ridge 40x120	 	1	2600
A	TL-1	Log 28x114	 	1	2600
B	TL-1	Log 28x114	 	1	2600
A	LG-3	Log 28x114		1	2400
B	LG-3	Log 28x114		1	2400
	IFB	IFB 70x40	 	4	2390
A	LG-2	Log 28x114		1	2300
B	LG-2	Log 28x114		1	2300
A	LG-1	Log 28x114		15	2200
B	LG-1	Log 28x114		15	2200
	FB	FB 17x114	 	22	1941
2	LG-2	Log 28x114		1	1877
1	LG-4	Log 28x114		1	1877
	RB	17x114	 	48	1440
1	BL-2	Log 28x57		1	1395
1	LG-5	Log 28x114		8	1395
2	LG-1	Log 28x114		1	944
1	LG-3	Log 28x114		1	944

# HB 2420 ET-EF 28 (240X200)

## List of all items 2

1	BL-1	Log 28x57		1	355
1	LG-2	Log 28x114		26	355
1	LG-1	Log 28x114		9	270

BB	BB 20x40		4	2400
----	----------	---	---	------

RR1	Roof reinforcement 18x95		2	2600
RR2	Roof reinforcement 38x38		2	2600
EE	Eave Edging 18x40		4	1480
RF	Roof Fascia 18x120		4	1480

Windboard 18x40		4	2200
-----------------	--	---	------

### ⑧ Gable 1

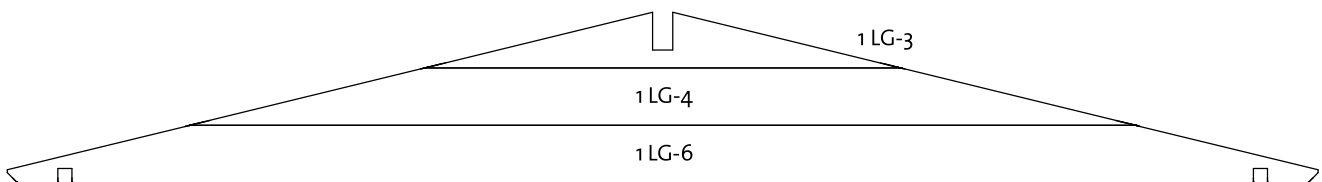

### ⑨ Gable 2

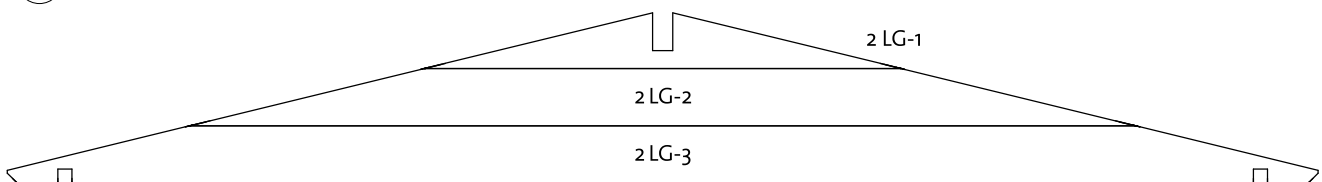

# HB 2420 ET-EF 28 (240X200)

## List of items 3

Door Schedule				
Mark	Type	Width	Height	Count

BD3R	Basic door 3 right	840	1955	1
------	--------------------	-----	------	---

DCB6	Door Crossbar 6	--	--	1
------	-----------------	----	----	---

Window Schedule				
Mark	Type	Width	Height	Count

BW1R	Basic window 1 right	765	990	1
------	----------------------	-----	-----	---







WCB6	Windows Crossbar 6	--	--	1
------	--------------------	----	----	---

Family	Count
--------	-------

Romb	2
------	---



Fasteners & Extras			
Name	Type	erqerwe	Count

Hitblock	300-400 mm		
Screws	5,0 x 70		10
Bolts	M8 x 60		12
Screws	6,0 x 140		25
Nails	1,4x40		30
Screws	4,0 x 40		60
Screws	4,0 x 50		220

